

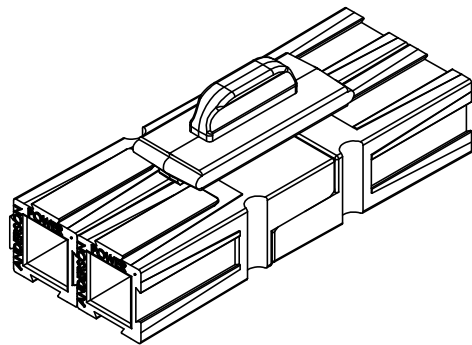

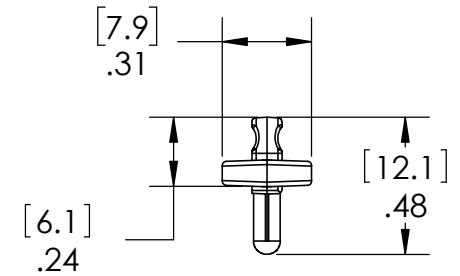
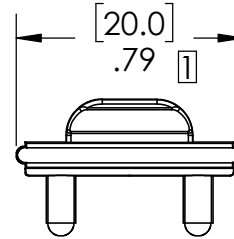
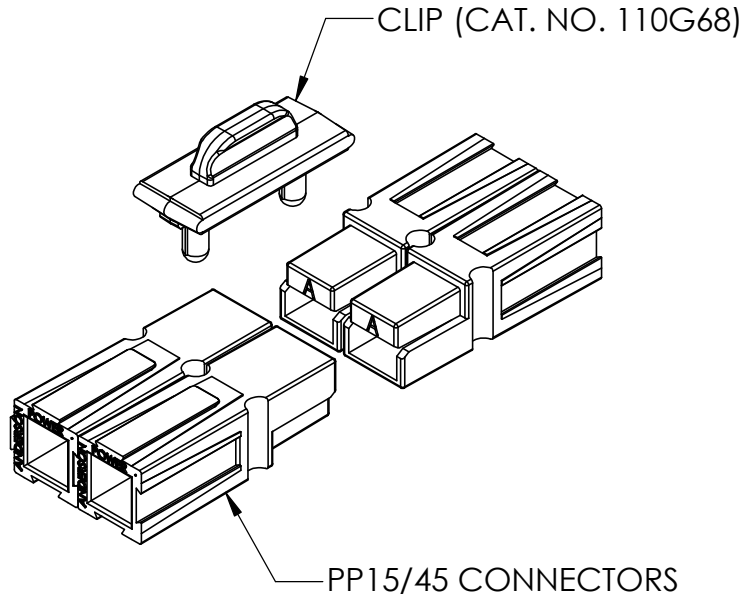

THE INFORMATION CONTAINED IN THIS DRAWING IS THE SOLE PROPERTY OF ANDERSON POWER PRODUCTS. ANY REPRODUCTION IN PART OR WHOLE WITHOUT THE WRITTEN PERMISSION OF ANDERSON POWER PRODUCTS IS PROHIBITED.

Copyright 2007

ANDERSON POWER PRODUCTS RESERVES THE RIGHT TO ALTER PRODUCT TYPES, THEIR TECHNICAL DATA, DIMENSION, STYLE AND ACCESSORIES WITHOUT PRIOR NOTIFICATION.



NOTE: CONNECTORS SOLD SEPARATELY

DIMENSIONS ARE IN:		INCH[MM]	APPROVALS		 <b>ANDERSON POWER PRODUCTS</b>		
UNLESS OTHERWISE STATED			<b>DRAWN</b>	AMS 01/24/07		<b>TITLE</b>  RETENTION CLIP FOR PP15/45 CONNECTORS	
TOLERANCES:			<b>CHECKED</b>	DJD 01/25/07			
DECIMALS (INCH)	DECIMALS (MM)	ANGLES	<b>MFG APP</b>	CHB 01/25/07			
.XX ±.02	.X ±.5	±2°	<b>QC APP</b>	UFN 01/24/07			
SURFACE FINISH:			<b>ENG APP</b>	DAM 01/24/07	SIZE	DWG NO.	REV.
MACHINED		128 [3.2] ✓			A/A4	114717S1	1
MOLDED		64 [1.6] ✓			SCALE	CADFILE	SHEET
MATERIAL: POLYCARBONATE					NONE	02628	1 OF 1
FINISH:					-CAD GENERATED DRAWING- DO NOT MANUALLY UPDATE DO NOT SCALE		
 3rd ANGLE PROJECTION			 1st ANGLE PROJECTION				

1	ECN 2016-0114: .79 WAS .82	CMS	12/2/2016
REV.	DESCRIPTION	APPRV	DATE
REVISIONS			