

8 7 6 5 4 3 2 1

THE INFORMATION CONTAINED IN THIS DRAWING IS THE SOLE PROPERTY OF ANDERSON POWER PRODUCTS. ANY REPRODUCTION IN PART OR WHOLE WITHOUT THE WRITTEN PERMISSION OF ANDERSON POWER PRODUCTS IS PROHIBITED.

Copyright 2013

ANDERSON POWER PRODUCTS RESERVES THE RIGHT TO ALTER PRODUCT TYPES, THEIR TECHNICAL DATA, DIMENSION, STYLE AND ACCESSORIES WITHOUT PRIOR NOTIFICATION.

COMPONENTS INCLUDED		
ITEM	QTY	DESCRIPTION
1	1	IN-LINE RECEPTACLE SHELL (MALE)

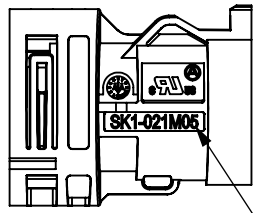
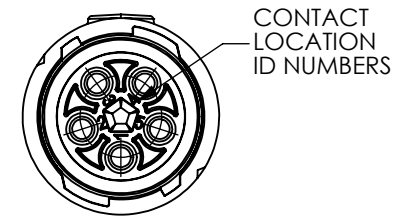
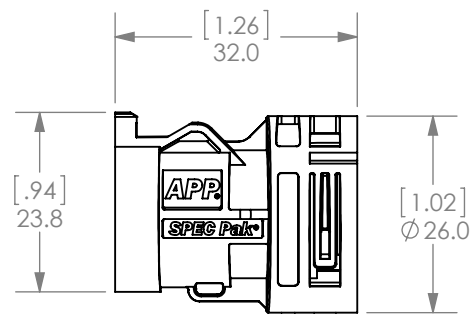
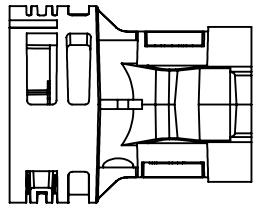
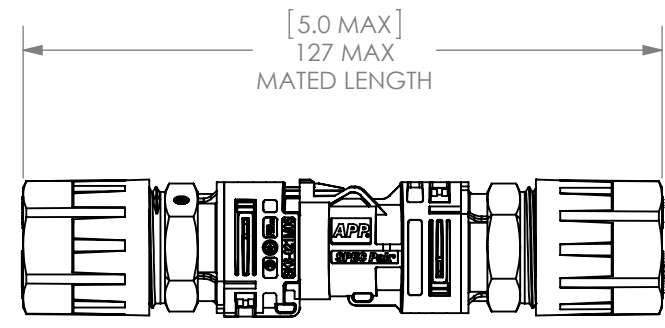
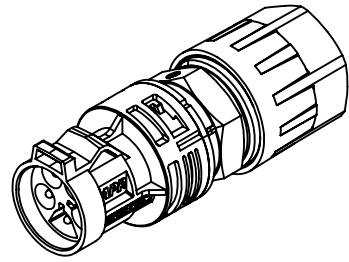
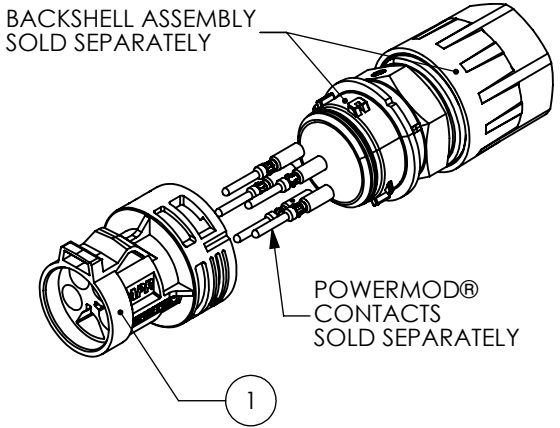

PART NUMBER (SEE SHEET 2 FOR KEYING)

[.81] Ø20.5

PART NO: SK1-021M05
SEE SHEET 2 FOR ADDITIONAL KEYS

- NOTES:
 1. MATERIAL: PC, BLACK
 2. FOR USE WITH POWERMOD® PIN CONTACTS (SOLD SEPARATELY)
 3. REFER TO ASSEMBLY INSTRUCTIONS 1S6617

DIMENSIONS ARE IN:	MM [INCH]	APPROVALS			ANDERSON POWER PRODUCTS		
UNLESS OTHERWISE STATED		DRAWN	10/7/2013		TITLE 5-POSITION MINI-PL SPEC PAK® IN-LINE RECEPTACLE SHELL (MALE)		
TOLERANCES:		NTS					
DECIMALS (INCH)	DECIMALS (MM)	CHECKED	1/23/2014				
.XX ±.02	.X ±.5	MM					
SURFACE FINISH:		MFG APPRV	1/24/2014				
MACHINED	3.2µ [128µin]	CHB					
MOLDED	1.6µ [64µin]	QC APPRV	1/23/2014				
MATERIAL: SEE NOTE 1		UFN					
FINISH:		ENG APPRV	1/23/2014	SIZE	DWG NO.	REV.	
		CMS		A	115307S1	1	
3rd ANGLE PROJECTION		-CAD GENERATED DRAWING- DO NOT MANUALLY UPDATE DO NOT SCALE		SCALE	CADFILE	SHEET	
				NONE	04071	1 OF 2	

1	ECRN-15568	TWE	2/6/2014
REV.	DESCRIPTION	APPRV	DATE
REVISIONS			

8 7 6 5 4 3 2 1

8 7 6 5 4 3 2 1

THE INFORMATION CONTAINED IN THIS DRAWING IS THE SOLE PROPERTY OF ANDERSON POWER PRODUCTS. ANY REPRODUCTION IN PART OR WHOLE WITHOUT THE WRITTEN PERMISSION OF ANDERSON POWER PRODUCTS IS PROHIBITED.

Copyright 2013

ANDERSON POWER PRODUCTS RESERVES THE RIGHT TO ALTER PRODUCT TYPES, THEIR TECHNICAL DATA, DIMENSION, STYLE AND ACCESSORIES WITHOUT PRIOR NOTIFICATION.

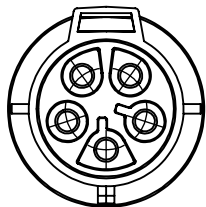

SK1-021M05

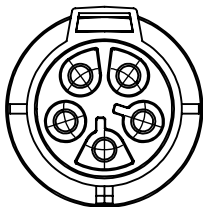

SK1-A21M05

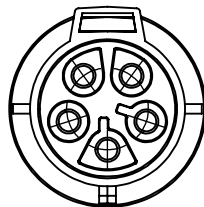

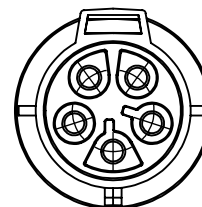

SK1-B21M05



SK1-F21M05

NOTE:
CONTACT FACTORY FOR
ADDITIONAL KEYS

DIMENSIONS ARE IN:		MM [INCH]	APPROVALS		 ANDERSON POWER PRODUCTS
UNLESS OTHERWISE STATED			DRAWN NTS	10/7/2013	
TOLERANCES:			CHECKED MM	1/23/2014	TITLE 5-POSITION MINI-PL SPEC PAK® IN-LINE RECEPTACLE SHELL (MALE)
DECIMALS (INCH)	DECIMALS (MM)	ANGLES	MFG APPRV CHB	1/24/2014	
.XX ± .02	.X ± .5	±2°	QC APPRV UFN	1/23/2014	
SURFACE FINISH:			ENG APPRV CMS	1/23/2014	
MACHINED 3.2µ [128µin] ✓			MATERIAL: SEE NOTE 1		SIZE A
MOLDED 1.6µ [64µin] ✓			FINISH:		DWG NO. 115307S1
MATERIAL: SEE NOTE 1			-CAD GENERATED DRAWING- DO NOT MANUALLY UPDATE DO NOT SCALE		REV. 1
FINISH:					SCALE NONE
					CADFILE 04071
					SHEET 2 OF 2

-	SEE SHEET 1	-	-
REV.	DESCRIPTION	APPRV	DATE
REVISIONS			

8 7 6 5 4 3 2 1